

REV 版本	MODIFICATION 修改	DATE 日期	DRAWING 繪圖	CHECKED 審核	APPROVED 核准
1					

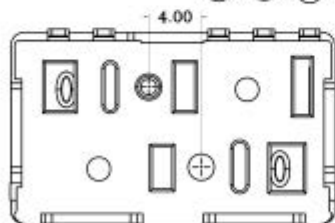

Circuitry

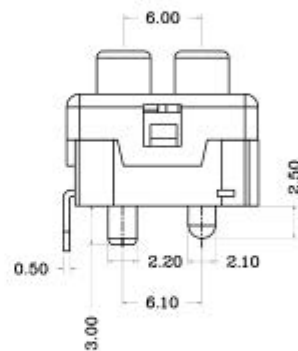
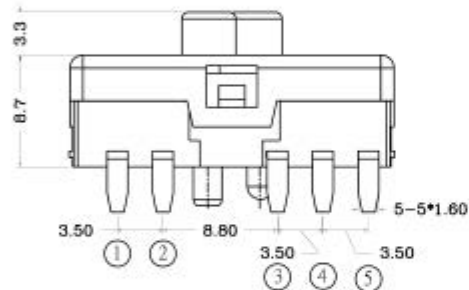
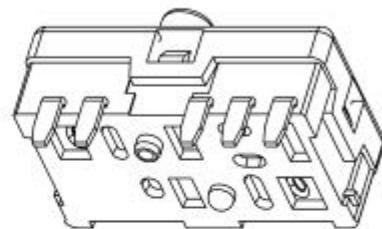
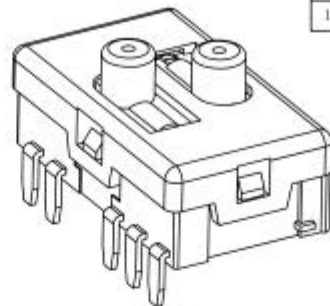
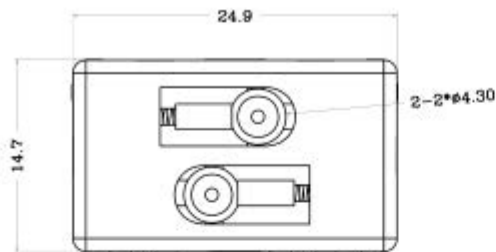
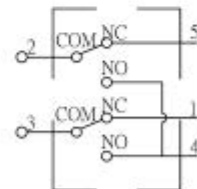

NTE

NTE INTERNATIONAL CO., LTD

NAME
名稱
DWG NO.
料號
MATERIAL
材質

推柄开关
RSW2-04-ST1

QUANTITY
數量
H R C
硬度
SCALE
比例
UNIT
單位

SCALE
MM

SIZE
紙張
SHEET
頁數
REV
版本
DATE
日期

A4
1/1
A/0
2019/07/09

DSGD
繪圖
PROJ
設計
CHKD
審核
APPD
核准

DIM TOL
X ±0.30 X.XX ±0.10 X ±5' X ±3' X.X ±0.20 X.XXX ±0.05 .XX ±1'

Ang Tol
成品圖